

PIK-20 E Repair manual

**REPAIR MANUAL**  
for  
**SELF LAUNCHING SAILPLANE**  
**PIK-20 E**

Approved by National Board of Aviation  
Edition 2  
January 1980



12.03.80

**EIRI KY**

Kisällinkatu 8  
SF-15170 Lahti 17

ILMAILUHALLITUS  
Lentoturvallisuusosasto

N:o 02732

## PIK-20 E Repair manual

### LOG OF REVISIONS

Any revision of the present Manual must be recorded in the following table. The new amended text in the revised page will be indicated by a black vertical line in the left hand margin and the Revision No. and date will be shown on the bottom of the page.

Rev. No.	Revised Pages	Description of Revision	Date	Signed
Edition 2	All pages	New Edition (Replaces previous edition dated November 1978)		

**EIRI KY**

Kisällinkatu 8  
SF-15170 Lahti 17

## PIK-20 E Repair manual

	Page
III REPAIR MANUAL	
TABLE OF CONTENTS	
1. FOREWORD	III- 1
2. REPAIRING IN GENERAL	III- 2
Tools	
3. REPAIRING OF REINFORCED PLASTIC LAMINATES	III- 3
3.1 Broken monocoque structure	III- 4
3.2 Broken outer surface of sandwich plate	III- 5
3.3 Hole in sandwich plate	III- 6
3.4 Finishing	III- 8
4. REPAIRING OF CRACKS IN ACRYLIC SHEET	III- 9
5. REPAIRING OF METAL PARTS	III-11
6. INSPECTION OF FUEL TANK	III-12
7. INSPECTION OF WATER TANKS	III-12
8. OTHER REPAIRS	III-13
9. GLASS FIBRE CLOTHS USED IN DIFFERENT PLACES	III-13
10. RAW MATERIAL LIST FOR PLASTIC STRUCTURES	III-16

**EIRI KY**

Kisällinkatu 8  
SF-15170 Lahti 17

page iii

## PIK-20 E Repair manual

### 1. FOREWORD

The intention of this repair manual is to give the basic advice needed for repairing small structural damage to the PIK-20 sailplane made of glass- and carbon fibre reinforced plastic (GRP and CFRP). Basic information about GRP and CFRP is not given in this manual because the repair worker is assumed to have professional knowledge of repairing items of GRP and CFRP. The repairing of sailplanes is not a proper field for practising GRP and CFRP laminating.

Before starting the work, study carefully what kinds of material, supplies, tools and work methods are required. You will find the answers in this manual. To maintain the excellent performance figures of the sailplane the surface quality should be equal to the original one.

If there are doubts about repairing structural damage always contact the manufacturer to find out what can and what cannot be done.

The information given in this booklet applies to minor repairs, such as a hole in the bottom of the fuselage caused by a gear-up landing, a handling accident in hangar etc.

Major repairs must not be accomplished before contacting the manufacturer or their representative. Typical repairs that must be considered major are:

1. Damage to the wing spar
2. Damage to the wing root rib
3. Damage to the fuselage main bulkheads
4. A hole in the wing trailing edge that damages the rear spar of the wing
5. Damage to the vertical stabilizer/fuselage fitting and bulkhead
6. Damage to the horizontal stabilizer fitting
7. Damage to the control surfaces that includes holes, cracks or other damage that reach 20% of the chord into the structure
8. Holes, cracks or other damage in the wing that are larger than 15 cm (6 in) in diameter or 25 cm (10 in) in length

**EIRI KY**

Kisällinkatu 8  
SF-15170 Lahti 17

page III-1

### 2. REPAIRING IN GENERAL

During rough landings, ground loops or when exceeding the permitted load factors during flight the largest calculated state of load might be exceeded. Damage arising in this way can be difficult to observe but it can cause the structure to become weaker so that the sailplane is strong enough, in normal circumstances, but not in situations with increased load. After these cases the sailplanes must be properly examined because the lamination may be broken. In disintegration of GRP laminates, part of the fibres break and one part becomes loose from the plastic bond. The lamination becomes partly or completely white and opaque depending on how large the damage is. The structure must be repaired because of its incapacity for load in all situations. Repair the damaged section by laminating the necessary cloths on top of the structure or remove the damaged place and relaminate the whole area.

These kinds of breaks are also sensitive to humidity because water can permeate into the lamination along the fibres and the bond between plastic and the fibre becomes weaker, therefore making the lamination also weaker.

#### NOTE

After a rough landing or ground loop the area surrounding the main wing pin, landing gear and its fittings, elevator fittings and the bonding lines of the ribs in the fuselage and in the root of the fin must be thoroughly examined for possible damage.

When starting the repair the quality of cloth used, the amount and the direction of fibres must all be known. To find this out sand the lamination with sandpaper or burn some plastic from a little piece which has been removed. In this way you can see the cloth directions clearly.

It is important to remember from which place and direction the piece of lamination has been removed. Paragraph 9 in this manual treats the structures used in most important surfaces and also the quality of cloth, amount and direction of laying.

Let us remind that in repairing the laminated structure it is a question of bonding the patch on the structure with the resin, thus the repaired section is not equal to the original one. If the bevels and relaminations are broad enough, the new joint is also firm enough to carry the same stresses as the original structure.

### TOOLS

- Accurate scales for preparing the right mixture of resin
- Jars and sticks for mixing
- Brushes for spreading of resin
- Mohair roller for spreading of resin on large area
- Iron roller for damping fibres and eliminating air bubbles
- Scissors for cutting glass fibre cloth
- Tape
- Plastic film for high temperature tent
- Hot air blower (hair drier)
- Sandpapers of different degree of fineness
- Knife
- Hack-saw blades for cutting of reinforced plastic
- Protective gloves

### 3. REPAIRING OF REINFORCED PLASTIC LAMINATES

Cases of damage that can be self-repaired are usually one of the following three:

- Broken monocoque structure
- Broken surface of sandwich plate
- Hole in sandwich plate

3.1 BROKEN MONOCOQUE STRUCTURE

(Fuselage)

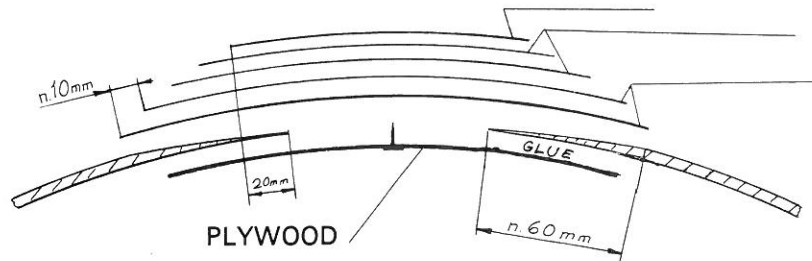

(cloth ref see pages 13-16)

Figure 1

Firstly determine how large the damage is by carefully sanding the surface paint to where the lamination seems to be unbroken. No whitening or capillary chinks allowed. Then remove the broken area and bevel the edges approximately 60 mm. It is a good practice to roughen the area outside the bevel about 30 mm wide so that the cloths outside the bevel bond as well.

In general the area under repair must be kept clean from dirt (dust, humidity, grease) already before the first opening is made. Be sure that the area is kept clean between laminations.

Hands and tools must also be kept clean. Brushes must be washed with grease soluting solvent (acetone, trichlorethylene) and dried before lamination. Protective gloves should be used.

Wash hands with soap and water and never with solvent.

The principle of bevelling is that the smallest (uppermost) cloth is 20 mm larger than the hole and the next cloth is always 10 mm larger than the previous one.

The order of lamination is the same as in the original structure, however, the undermost cloth is largest (at least the same size as the bevelled area).

The quality and direction of the cloths must always be the same as in the original lamination. Use an iron roller to eliminate air bubbles: in this way the cloths also become better wetted. During this period use some film (cellophane, or usual plastic film) to cover the area you are patching, and remove the air under the film using a trowel. This way you will get a smoother surface and there is less finishing to do. Remove the film when the resin has hardened. If the hole is big the area should be propped in some way in order to obtain good results when laminating. This can be done for instance by fastening a thin sheet of plywood with glue on the inner side. (See Figure 1). The sheet of plywood can be left there because being glued it will not come loose from the lamination.

If you cannot reach the hole from the inner side, make an oval hole and have a prop which can be layed on place through the oval hole. Before placing the prop set a fastening pin or iron wire (See Figure 1) so that the prop can be held in place during lamination.

3.2 BROKEN OUTER SURFACE OF SANDWICH PLATE

(Wing and control surfaces.)

In principle this is done just as in the previous case above. The width of the patched area is defined by the outer surface and the broken PVC-foam area. Remove the broken (= softened) PVC-foam and fill the hole with a mixture of microballoon and resin which in the following is called "balloon". The viscosity of the balloon has to be thick enough to stay on a stick without dropping. After the resin has hardened the area should be grinded smooth and cleaned from dust. After this the surface laminate will be repaired as in the previous section "Broken monocoque structure".

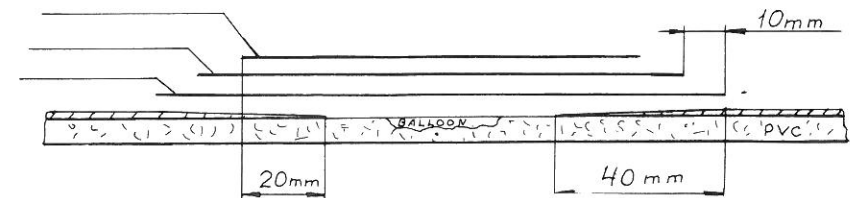

Figure 2

(cloth ref. see pages 13-16)

## PIK-20 E Repair manual

### 3.3. HOLE IN SANDWICH PLATE

(Wing and control surfaces.)

First make the hole larger so that the edges are solid. Remove enough PVC-foam so that a strip approximately 20 mm wide is left around the hole. (See Figure 3). Roughen the strip. After this the manner of proceeding is the same as in paragraph "Broken monocoque structure". A thin sheet of plywood can be used for support. After this you can laminate (45° 92125) on the support and on the inner solid cloth. Let it harden. Thicker glass weave (92125) is used as inner cloth instead of the original one (92110 or 90070) so that laminating is easier. Glue a same size PVC-foam piece in the hole with balloon. Put carefully a load on the piece of foam to make it bond better to the lamination.

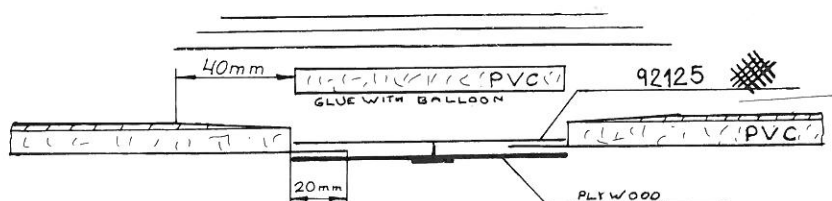

Figure 3

(cloth ref. see pages 13–16)

## PIK-20 E Repair manual

When the glue has hardened, sand the area smooth and make a bevel the same way as in the paragraph "Broken monocoque structure". Fill the pores of the PVC-plate and laminate the cloths immediately.

When the hole is larger first glue the inner laminate to the PVC-plate. To begin, the manner of proceeding is the same as in the previous case. Fill the pores of the PVC-plate with balloon and fit the plate to suit the hole, then laminate the cloth of the inner surface immediately to the PVC-plate. When this has hardened glue a sheet of plywood as a prop and draw a nail or iron wire through the plate and plywood. Then glue the PVC-plate on the area with balloon (see Figure 4). Use a load or iron wire to accomplish pressing. Do not use too much force because then the inner laminate may come loose from the PVC-plate.

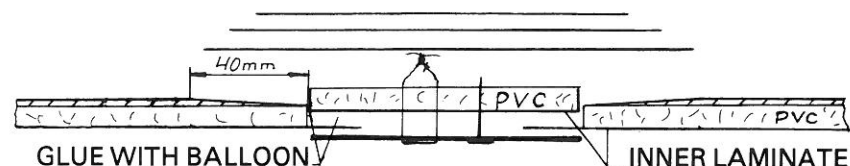

Figure 4

(cloth ref. see pages 13–16)

The third way to patch a hole in sandwich plate is to first prepare the patch and bond line together. Remove all broken parts of the hole and leave no inner laminate as an edge. Shape the PVC-plate to the hole and glue the previously prepared piece of cloth laminate to the PVC-plate. The piece of laminate consists of two cloths (/// 45° 92146 + \\\ 135° 92146 or 2 × 92140 or 3 × 92125 ± 45°), which overlap the edge by approximately 40 mm (See Figure 5). Perform the lamination of the cloth on a table on top of plastic film or 2 – 3 layers of wax and one layer of PVA. After glueing, cut the pieces of laminate to a suitable size.

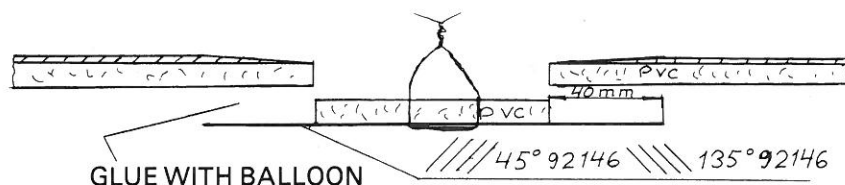

Figure 5  
(cloth ref. see pages 13–16)

Roughen the bond lines. Then glue the patch with balloon. Make an oval for reaching the hole from the inner side. Use iron wire to accomplish pressing. When the resin has hardened continue the work as usual.

**NOTE**

Especially when you are glueing "blindly" use enough balloon so that air is eliminated from the bond line. For this purpose make the bond line approximately 40 mm wide.

**NOTE**

When repairing the control surfaces it is important to prevent an increase in the weight. This usually causes the center of gravity to shift and so that control surfaces must be massabalanced again.

**3.4 FINISHING**

The repair has to be done so that the patched area is no higher than surrounding surface. The right shape is obtained by filling the area with balloon which sticks better than the polyester putty used for finishing. A long straight splint is used for spreading the balloon. Before every spreading, the surface has to be roughened with sandpaper grade number 100. Use polyester putty on the surface after the shape is accurate enough (Lesonal, Pakla, P2/55, Plastic Padding) and finish the surface with sandpapers up to 320. Watch that the uppermost cloth will not be damaged. If the cloth comes into sight during grinding the patch is too high and has to be done again or make the surrounding surface thicker with putty, but in this case, the patch will be seen afterwards. Regarding the fuselage, a small overthickness is not harmful.

A paint sprayer is recommended for the painting and the layers should be thick enough that the polishing can be done without all of them (5 to 6 layers crossway) being sanded away. The surface is then sanded wet with sandpapers up to 600 and finished with paint polishing agent and waxed if necessary. For waxing the sailplane, a normal car wax is good enough but not, however, one which contains silicone. Note: To avoid bubbles on patched areas it is recommended to spray first the area with Inerta 51 HB epoxy primer, then fill with polyester putty, sand and paint again with Inerta 51. This layer can be sanded wet up to grade 320 (do not sand through epoxy primer layer) and then be painted with acryl paint. The paint shop air moisture content must be lower than 50 %. A moisture drying cycle before first paint and after sanding wet is recommended in 40°C, moisture content must be lower than 20 %.

**4. REPAIRING OF CRACKS IN ACRYLIC SHEET**

Before starting the work, prevent the progression of the crack by drilling a 2 mm hole at both ends of the crack. Then open the crack and fill it with acryl glue starting from the bottom of the V. (See Figure 9). Use Tensol no. 7 for glueing. Fill the crack, layer by layer, and let the layers harden in between to prevent air bubbles because the glue shrinks while hardening. When the crack has been filled and the glue is hard, grind the patch smooth first with fine wet and dry sandpaper and afterwards

## PIK-20 E Repair manual

with grinding pastes and liquids so that the bond line becomes transparent. To begin use sandpaper no. 600 for eliminating scratches and defects of the surface if they are deep. Fasten the paper on a soft grinding tool which has curved edges. Do the grinding by gently rotating with help of the weight of the fingers. After this use grinding paste ("Perspex" Polish no. 1) which is also good for starting to repair very small cracks. Spread the paste with a soft piece of cloth or grinding disc if a grinding machine is available. Change the cloth frequently; the paste must not dry on the cloth. The grinding pressure must be very light. Remove the paste with a clean piece of cotton cloth. After this, polish with polishing liquid ("Perspex" Polish no. 2A). Use the same piece of cloth both for spreading and polishing. Take care that the piece of cloth is clean from dust and dirt during the work. Use "Perspex" Polish no. 3 to remove possible static electricity due to grinding and polishing. If neces-

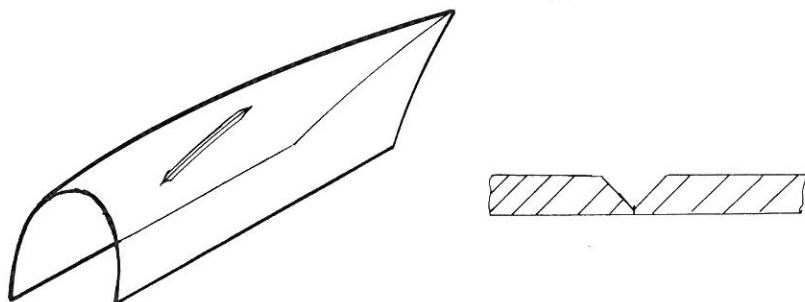

Figure 6

sary use water to make the Polish thinner and spread the Polish on the canopy with a soft, humid cloth. Use a clean, soft and dry cloth for rubbing the canopy shiny. You can also wash the canopy with a solution consisting of 10 % "Perspex" Polish no. 3 and 90 % water.

The use of organic solutions (as solvents of paint and turpentine) is forbidden.

**EIRI KY**

Kisällinkatu 8  
SF-15170 Lahti 17

## PIK-20 E Repair manual

### 5. REPAIRING OF METAL PARTS

The steel parts of the sailplane are made of chrome molybdenum steel AISI 4130 MIL-S-18729C or MIL-T-6736B, LN 1.7214.4 or .9 or 25CrMo4 according to DIN 71200.

The steel plates and tubes have been in normalized condition. Temper hardened steel  $\sigma_m = 900 \text{ N/mm}^2$  has been used as the material for the turned parts. The main wing fittings are temper hardened to  $\sigma_m = 1000 \text{ N/mm}^2$  and the wheel axle to  $\sigma_m = 1150 \text{ N/mm}^2$ . Other steel parts have been dimensioned according to the condition after gaswelding.

If an inert gas welding system (TIG) is used, it is necessary to carry out normalizing process. Parts must be annealed 4–5 min in 840–880°C temperature and then cooled in box in normal temperature. If the part has been plated with cadmium or zink, it must be completely removed before welding with removal bath.

After welding, jet blast with sand. A high quality metal primer is recommended (e.g. Herberts Standox Reaktionsgrund) before painting the surface with a second coat (e.g. Herberts car paint). The interior surface of the warmed parts have to be protected once again against rust with protecting agent (Dinitrol ML or LPS3).

#### NOTE

Only a qualified welder is allowed to weld airplane parts.

The push rods are made of aluminium (DIN AlMgSiT6) or steel (DIN St35). All the bolts are milimetric high strength bolts. The bolts used in the control system are of close tolerance and these are sold by the manufacturer. The rudder cable is  $7 \times 19 \text{ } \phi 1/8''$  MIL-W-1511 A.

Eiri Ky recommends in any case to change all damaged parts because of the complicated repair process.

**EIRI KY**

Kisällinkatu 8  
SF-15170 Lahti 17



## 6. INSPECTION OF FUEL TANK

The fuel tank which is made of GRP (usable capacity 32 litres) can be checked and repaired as any GRP structure.

The KEVLAR fuel tank (usable capacity 28 litres) is CFRP reinforced and very strong. All repairs of the construction should be made by the manufacturer.

The fuel tank can be cleaned and inspected from the inside by removing fuel gauge transmitter from the top of the tank.

## 7. INSPECTION OF WATER TANKS

The water tanks of the sailplane are made of plastic, strengthened with nylon so they are very strong. It is, however, a good idea to inspect them annually.

Loosen the tanks from the main rib by loosening the tube connector from the inner end of the tank inside the wing and take the tank out from the hole in the main rib. The easiest way of inspecting the tanks is to look for humid areas or chafed places when the tanks are filled with water.

The tank can be repaired with original material by glueing a patch with contact glue (roughen carefully).

Tape the longitudinal seams of the tank against the bag. Fold the tank over in three parts. Push the tank into its place. The right installation is checked by filling the tank and measuring water quantity. Seal the main rib.

## 8. OTHER REPAIRS

The repairs of instruments, radios and oxygen systems must be performed according to instructions of the manufactures or aviation authorities.

## 9. GLASS FIBRE CLOTHS USED IN DIFFERENT PLACES

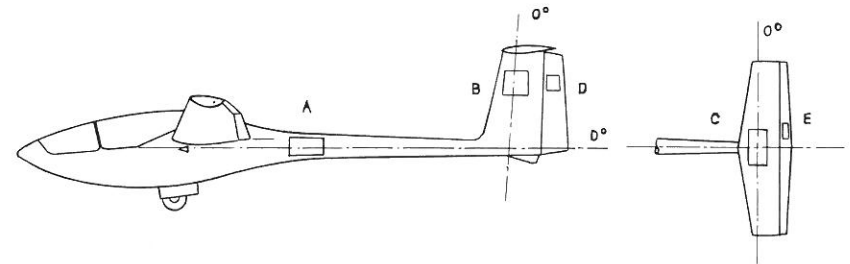

### A FUSELAGE

Surface paint

0° 90070

45° 92146

135° 92146

0° 92146

45° 92140

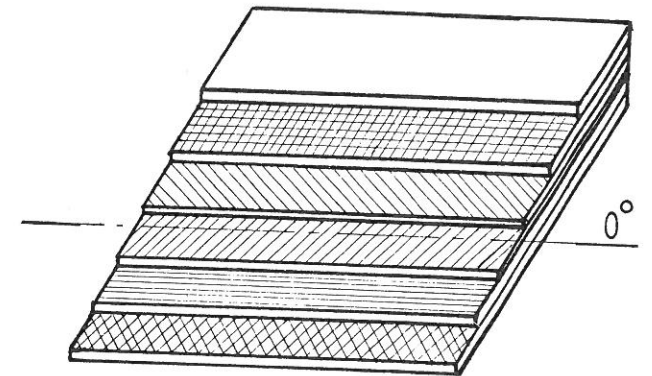

**PIK-20 E Repair manual**

**B VERTICAL STABILIZER**

- Surface paint
- 0° 92110
- 0° 92125
- 10 mm
- Hard PVC-foam
- Conticell 60
- 0° 92110

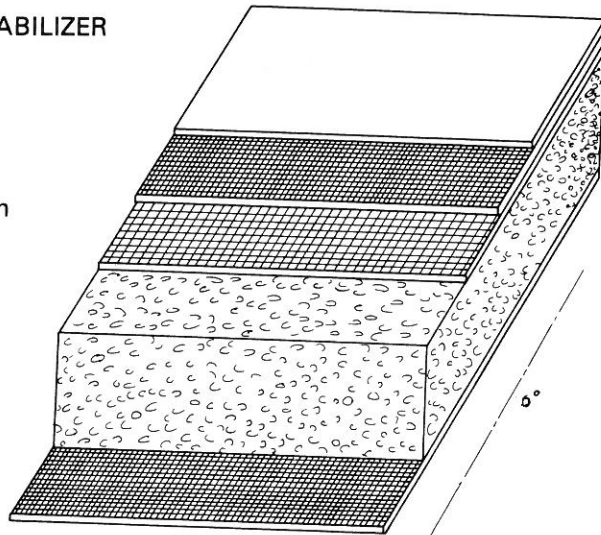

**C STABILIZER**

- Surface paint
- 0° 90070
- 0° 92125
- 5 mm
- Hard PVC-foam
- Conticell 60
- 0° 92110

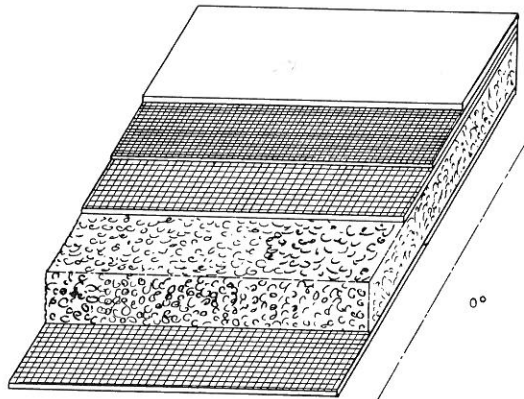

**D RUDDER**

- Surface paint
- 0° 92110
- 5 mm
- PVC-foam
- Conticell 40
- 0° 90070

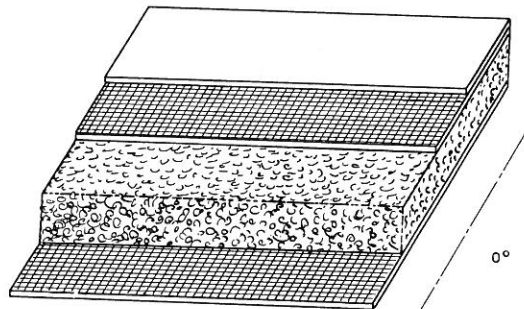

**EIRI KY**

Kisällinkatu 8  
SF-15170 Lahti 17

**PIK-20 E Repair manual**

**E ELEVATOR**

- Surface paint
- 45° 92110
- 3 mm
- PVC-foam
- Conticell 40
- 45° 90070

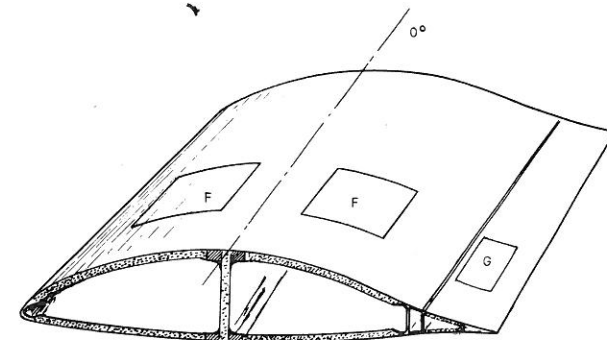
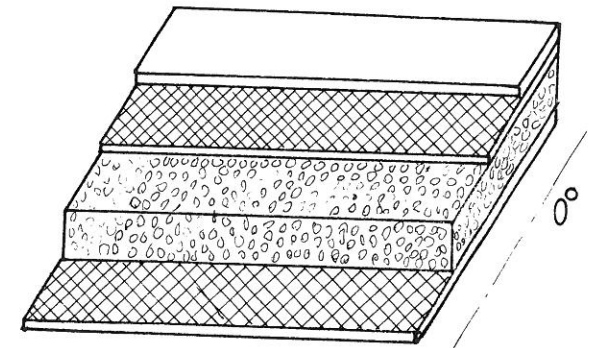

**F WING**

- Surface paint
- 45° 90070
- 45° 92125
- 10 mm
- PVC-foam
- Conticell 60
- 45° 92110

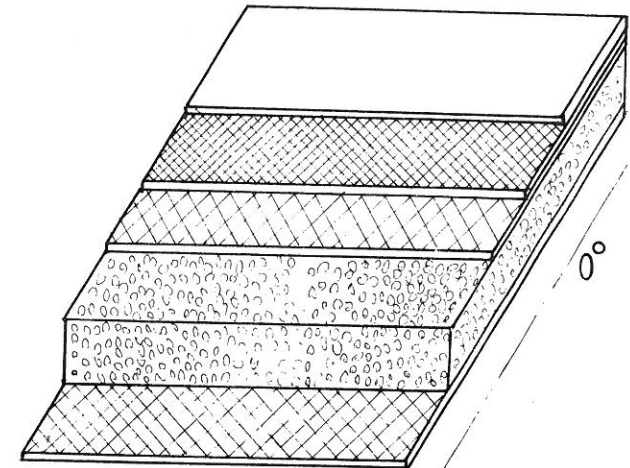

**EIRI KY**

Kisällinkatu 8  
SF-15170 Lahti 17

## PIK-20 E Repair manual

### G FLAPS/AILERONS

Surface paint

45° 90070

45° 92125

3 mm

Hard PVC-foam

Conticell 40

45° 90070

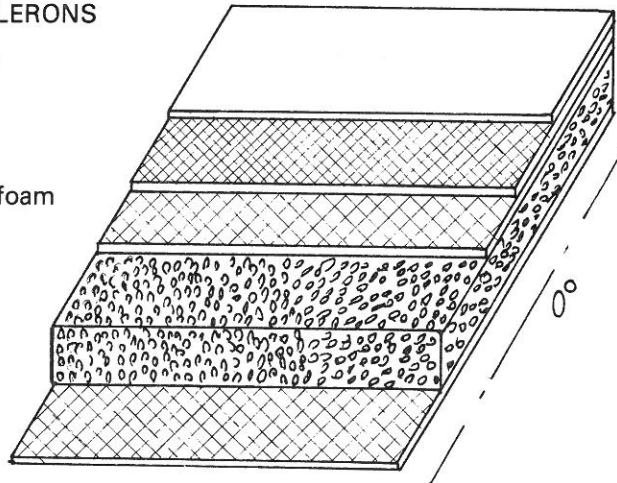

## 10. RAW MATERIAL LIST FOR PLASTIC STRUCTURES

Plastic

Resin Rütapox L 02 and L20

Hardener Rütapox H 91/SL

Mixture (mass parts):

	34 H 91	30 SL 50
	100 L 02 + 38 SL 50	100 L20 + 32 SL 75
	42 SL	34 SL

Manufacturer: Bakelite GmbH, Federal Republic of Germany

Glass fiber cloths

Manufacturer: Interglas GmbH, Federal Republic of Germany

Interglas no. (Finishing 1550) weight g/m<sup>2</sup> ± 5%

90070	80
92110	163
92125	280
92140	395
92145	215
92146	440

**EIRI KY**

Kisällinkatu 8  
SF-15170 Lahti 17

## PIK-20 E Repair manual

Rovings

RA 35T2448 M 15

Manufacturer: Scandinavian Glasfiber, Sweden

Finishing Araton

GARBON FIBRE

Grafil E/A-S 10000 filament

Manufacturer: Courtaulds Limited, England

Surface paint

Primer

Paint	2K-Standocryl	Inerta 70	Inerta 165	Inerta 51HB
Hardener	2K-Härter	Inerta 70 hardener	Inerta 165 hardener	Inerta 51 hardener
Solvent	11012	9506	9514	9514
Manufacturer	Kurt Herberts GmbH, Federal Republic of Germany	Teknos-Maalit Oy, Helsinki		

NOTE

Only white tints may be used, except on the color markings.

Core material of sandwich plates

Conticell 60 (60 kg/m<sup>3</sup>) and 40 (40 kg/m<sup>3</sup>)

Manufacturer: Continental Gummi-Werke AG, Federal Republic of Germany

Fillers

Microballoon: Eccosphere IG 101

Manufacturer: Emerson & Cumings, Belgium

Chopped fibres EC 10-S

Manufacturer: Gevetex Textilglas GmbH, Federal Republic of Germany

Release agents

Wax QZ 11 3

Manufacturer: CIBA AG, Switzerland

**EIRI KY**

Kisällinkatu 8  
SF-15170 Lahti 17

## PIK-20 E Repair manual

Polyvinylalcohol PVA Mould Release Agent No 3  
Manufacturer: Downland, England

### Protecting ointments for hands

(Suitable for epoxy resins)

Arretil Q (before lamination)

Stokolan (after washing and lamination)

Manufacturer: Stockhausen, Federal Republic of Germany

### Acryl plate

Plexiglas 240 3 mm thick

Manufacturer: Röhm GmbH, Federal Republic of Germany

### Repairing material for acrylic sheet

Acryl glue: "Tensol 7" and hardener

Grinding and polishing material for acryl

"Perspex Polish No. 1"

" " No. 2A

" " No. 3

Manufacturer: ICI, England